



Using the Funding & Tenders Portal:

What you need to know

Olivier MARGANNE

olivier.marganne@ext.ec.europa.eu

Common Implementation Centre – Business Processes – RTD H3

EU Login

Register Login



SEARCH FUNDING & TENDERS ▾ HOW TO PARTICIPATE ▾ PROJECTS & RESULTS WORK AS AN EXPERT SUPPORT ▾

Find calls for proposals and tenders

Search calls for proposals and tenders by keywords, programmes...

Search

Public access

ERA corona platform

Brexit info

Report fraud

EU Programmes

Programming period 2014-2020

European Maritime and Fisheries Fund (EMFF)

European Statistics (ESTAT)

Innovation Fund (INNOVFUND)

EU External Action (RELEX)

Hercule III (HERC)

Horizon 2020 Framework Programme (H2020)

Support for information measures relating to the common agricultural policy (IMCAP)

Internal Security Fund Borders and Visa (ISFB)

Internal Security Fund Police (ISFP)

Justice Programme (JUST)

Show all (30)

How to participate in 5 steps

1

Find an opportunity

2

Find partner(s)

3

Create an account

4

Register your organisation

5

Submit your proposal or offer

Learn how to find and apply for suitable EU funding and tender opportunities.

Learn more

News

29 Dec, 2020

Finding Calls for Tenders on the Funding and Tenders Portal

The EuropeAid website has been phased-out for Calls for Tenders but not for Calls for Proposals. External partners are invited to transition to the Funding and ...

18 Dec, 2020

DIGIT Support for eGrants and eProcurement external users are moving together

Within the context of the Synergies and Efficiencies Initiative, the DIGIT Support teams for eProcurement and for eGrants (GMSS) are now joining their forces un...

18 Dec, 2020

Attention: Phishing attempts through the contact functionality of the F&T Portal

Several Funding & Tenders Portal users reported to us that they received emails through the contact form of the F&T Portal ("Contact LEAR", "Contact Pro...

All news >

Useful links



Calls for tenders on Ted



Overview of all EU funding opportunities



Access to publications and data on OpenAire



Apply for EU loans & venture capital

Manage my area

- My Person Profile
- My Organisation(s)
- Grants
- My Proposal(s)**
- My Project(s)
- My Formal Notification(s)
- My Expert Area

Personalised access to the user account

Find calls for proposals and tenders

Search calls for proposals and tenders by keywords, programmes...

Personalised access to the IT tools

EU Programmes

Programming period 2014-2020

3rd Health Programme (3HP)	Asylum, Migration and Integration Fund (AMIF)	Consumer Programme (CP)	Creative Europe (CREA)	Europe Direct (ED)
European Defence Industrial Development Programme (EDIDP)	EU Aid Volunteers Programme (EUAID)	European Solidarity Corps (ESC)	Erasmus+ Programme (EPLUS)	Europe For Citizens (EFC)

[Show all \(30\)](#)

News

01 Dec, 2020
First Innovation Fund call for Small Scale Projects published on 1 December 2020
The first Innovation Fund call for Small Scale Projects has been published! Submission opening soon Submission deadline: 10 March 2021 ...

23 Nov, 2020
Horizon 2020 FAQs on grant management during the COVID-19 crisis continue to apply
Taking into account the current COVID-19 situation, the Commission confirms that the following FAQs, related to the management of Horizon 2020 grants under the ...

27 Oct, 2020
eProcurement: new version of eSubmission and new Tender details page in the Funding & Tenders Portal
When responding electronically to calls for tenders, for example to Open procedures, you will notice that some enhancements have been brought to eSubmission. Ha...

[All news >](#)

How to participate in 5 steps

- 1 Find an opportunity
- 2 Find partner(s)
- 3 Create an account
- 4 Register your organisation
- 5 Submit your proposal or offer

Learn how to find and apply for suitable EU funding opportunities.

[Learn more](#)

Useful links

- Calls for tenders on Ted
- Overview of all EU funding opportunities
- Access to publications and data on OpenAire

Funding & Tenders Portal: principles

- Single gateway for all exchanges, based on:

EU Login
Single sign-on
*(1 EU Login account
= 1 e-mail address = 1 person)*

+

IAM
Access rights
based on role authorisation

=

Personalised services on the Funding & Tenders Portal

- Brings homogeneity, transparency and better service integration for grant management.



EU Login



Create a new EU Login account

Creating a new EU Login account is fast and easy:

1. Click on the "Register" button
2. Enter your information (name & e-mail address)
3. Click on the link you receive via e-mail
4. Set up your password

Find calls for proposals and tenders

[ERA corona platform](#) [Brexit info](#) [Report fraud](#)

Search calls for proposals and tenders by keywords, programmes...

 Search

News

29 Dec, 2020

Finding Calls for Tenders on the Funding and Tenders Portal

The EuropeAid website has been phased-out for Calls for Tenders but not for Calls for Proposals. External partners are invited to transition to the Funding and ...

[Create an account](#)

Login

Create an account

[Help for external users](#)

First name

Last name

E-mail

Confirm e-mail

E-mail language

Enter the code



By checking this box, you acknowledge that you have read and understood the [privacy statement](#)

Create an account



Registering your organisation

—

Getting a PIC



How to Participate

1. Reference Documents

- List of all useful reference documents, grouped by Programme

2. Participant Register

- **PIC search:** Check whether your organisation is already registered /
Look for an existing PIC
 - Access the **organisation registration tool**
- PICs are required in the proposal submission system**



Reference Documents

Programming period

2014-2020

Horizon 2020 Framework Programme (H2020)

Clear filter

Reference Documents

Grants

This page includes reference documents of the programmes managed on the EU Funding & Tenders portal starting with legal documents and the Commission work programmes up to model grant agreements and guides for specific actions.

Please select the programme to see the reference documents.

Procurement

Reference Documents related to tendering opportunities are published on TED eTendering in the calls for tenders.

Filter

Expand all

- Legislation
- Work Programmes
- Grant agreements, contracts and rules of contest
- Guidance
- Templates & forms
- Expert names (annual lists)



Participant Register

Participant Register

 Need help?

If you want to participate in a project proposal or in a call for tenders with eSubmission, your organisation needs to be registered and have a 9-digit Participant Identification Code (PIC). Please quote your PIC in all correspondence with the Commission.

The register contains all participants of EU programmes.

Is your organisation already registered? PIC search

Please check whether your organisation has already been registered. If so, no need to register it again.

Search a PIC

Access the PIC search tool

Register your organisation

To register your organisation or as a natural person, you need to login into the Portal or, if you are a new user, create your account.

Check what information you need to register in the Online Manual - and keep it to hand during the registration procedure. To start registration, click on the button below.

Register your organisation

You can suspend the registration process at any time: the data entered can be saved as draft and you can continue your registration later. To return to your registration, please log in and get into My Organisation(s) in the My Area section. Incomplete, draft registrations are automatically deleted after one year.

For H2020 programme, please make sure to fill in the information required. Additionally, for actions where the SME assessment is required, please provide the necessary information.

Should your project or tender be successfully awarded, you must contact the Registration Service team before the signature of the Grant Agreement or of the Framework Contract.

Register an organisation



Welcome

Identification

Organisation

Contact

Summary

Success

Welcome to the Participant's Register

The Registration Wizard will guide you through the process of registration.

- ✓ Please keep the basic legal information (Registration extract, VAT data) of the organisation at hand so you can fill in the forms quickly and correctly.
- ✓ The registration process normally takes about 5-10 minutes to complete. The system will automatically save the information provided during registration in case you want to exit the wizard. Your data will be restored the next time you will access the Participant's Register.
- ✓ At the end, it will assign and display the PIC (Participant Identification Code) of your organisation.

Complete all 6 steps to receive your PIC



Welcome

Identification

Organisation

Contact

Summary

Success

Identification

Please fill in some preliminary information about your organisation required to check if this organisation has already been registered, as well as to identify any existing PIC numbers of similar organisations that could potentially match your request.

Legal name *



Establishment/Registration country *



Registration number



VAT number *

 VAT number not applicable

Website



**A background check for duplicate PICs
is taking place in parallel**



Research & innovation

Funding & Tenders Portal - Participant registration

European Commission > Research & Innovation > Funding & Tenders Portal > Participant Register

Welcome

Identification

Organisation

Contact

Summary

Success

Organisation

Fill in the information related to the organisation you want to register, as stated in your official documents (registration act/statute, VAT extract, etc)

Legal name and status

Legal name *



This Company Does Not Exist Ltd.

Describe the legal status of your organisation by selecting the appropriate options

Legal status



- a natural person a legal person
- private entity public body
- non-profit for profit

Registration data

Establishment/Registration country *



Belgium (BE)

Registration number



111222333

Registration date



Registration date dd-MM-yyyy



--Select one--

VAT number not applicable

Business name



Official language *



--Select one--

Legal Address

Enter the official registered address of the participant



Saved at: 22/19/11/2021

< Prev

Next >

**You may save and resume
your registration at any time**



Participant Register

Important remarks:

- **Registering an organisation requires an EU Login account**
- **The person who registers an organisation receives the Self-Registrant role:** this person is the contact person with the Commission services for this organisation until a LEAR is appointed
- When the registration is completed, the PIC number is provisional, meaning that the **submitted data then needs to be validated by the Validation Services**
- The validation of the organisation is only triggered once the organisation is part of a successful proposal; it is then flagged in the system with the Grant Signature date for the Validation Services to operate
- **All contact with the Validation Services must take place inside the Participant Register**



Services after login:

The Identity and Access Management (IAM)

Personalised services

The Funding & Tenders Portal allows each user to have access to a personalised space, based on 3 main elements:

- Each user is supposed to have a **unique EU Login account**, which is the **unique identifier for persons** (linked to their professional email address).
- Each EU Login account is linked to one (or more) **PIC number(s)**, which are the **unique identifier for organisations**.
- Each EU Login account is linked to all the roles that the user has in projects and/or organisations through IAM.
One user can have as many roles as necessary.

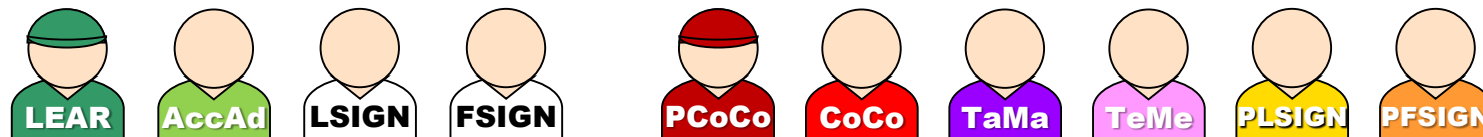



The Identity and Access Management

- The **I**ntity and **A**ccess **M**anagement allows us to define and/or manage changes of **access rights of users of the Funding & Tenders Portal**.
- It gives **a personalised and secure access to the different services** of the Funding & Tenders Portal.
- Minimum involvement by the Commission/Agency staff allowing for **flexibility in the online management of the consortium**.
- **Any change in the roles of the users is saved** to allow a monitoring & tracking service.

The Identity and Access Management

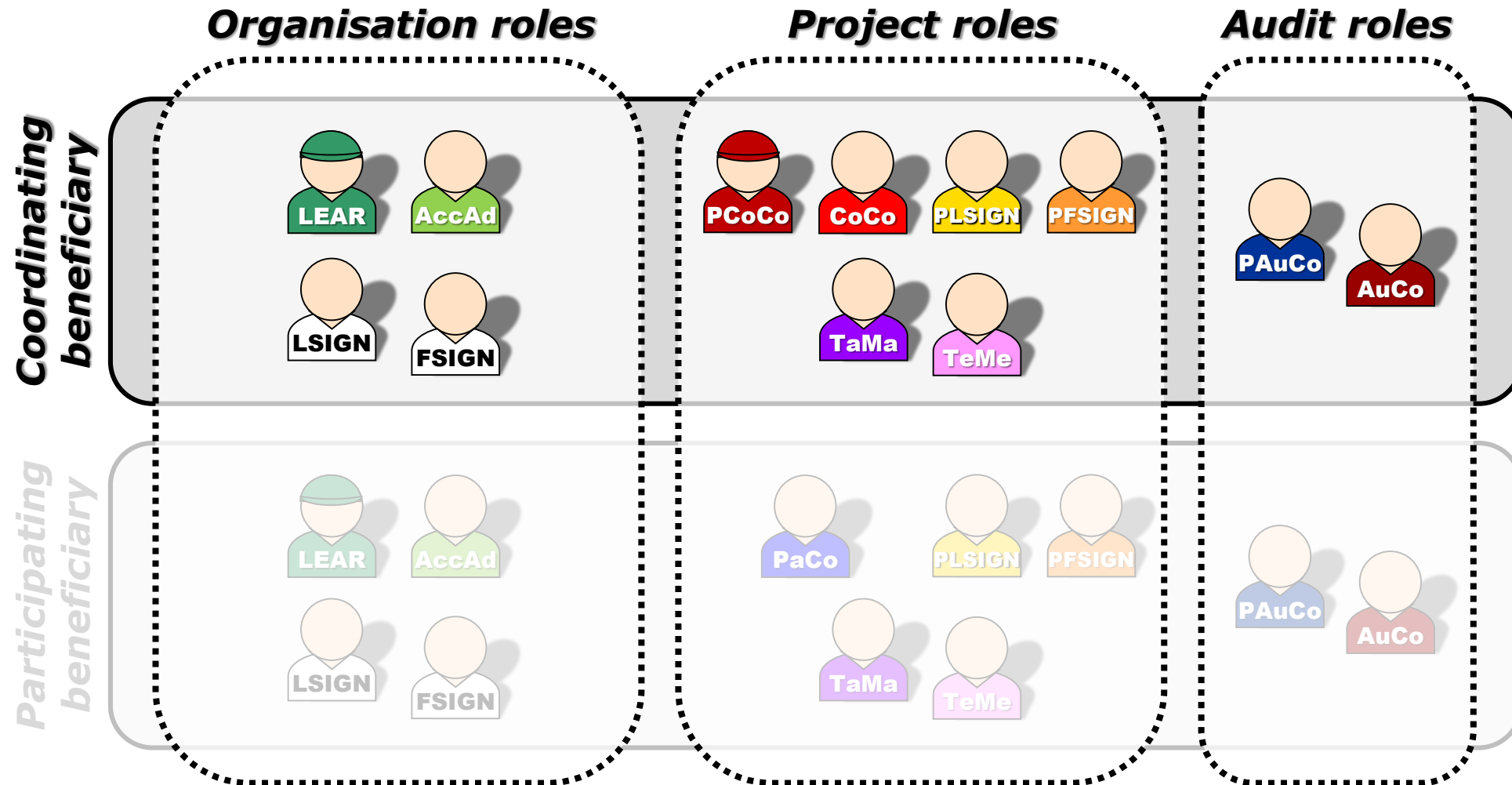

Nomenclature

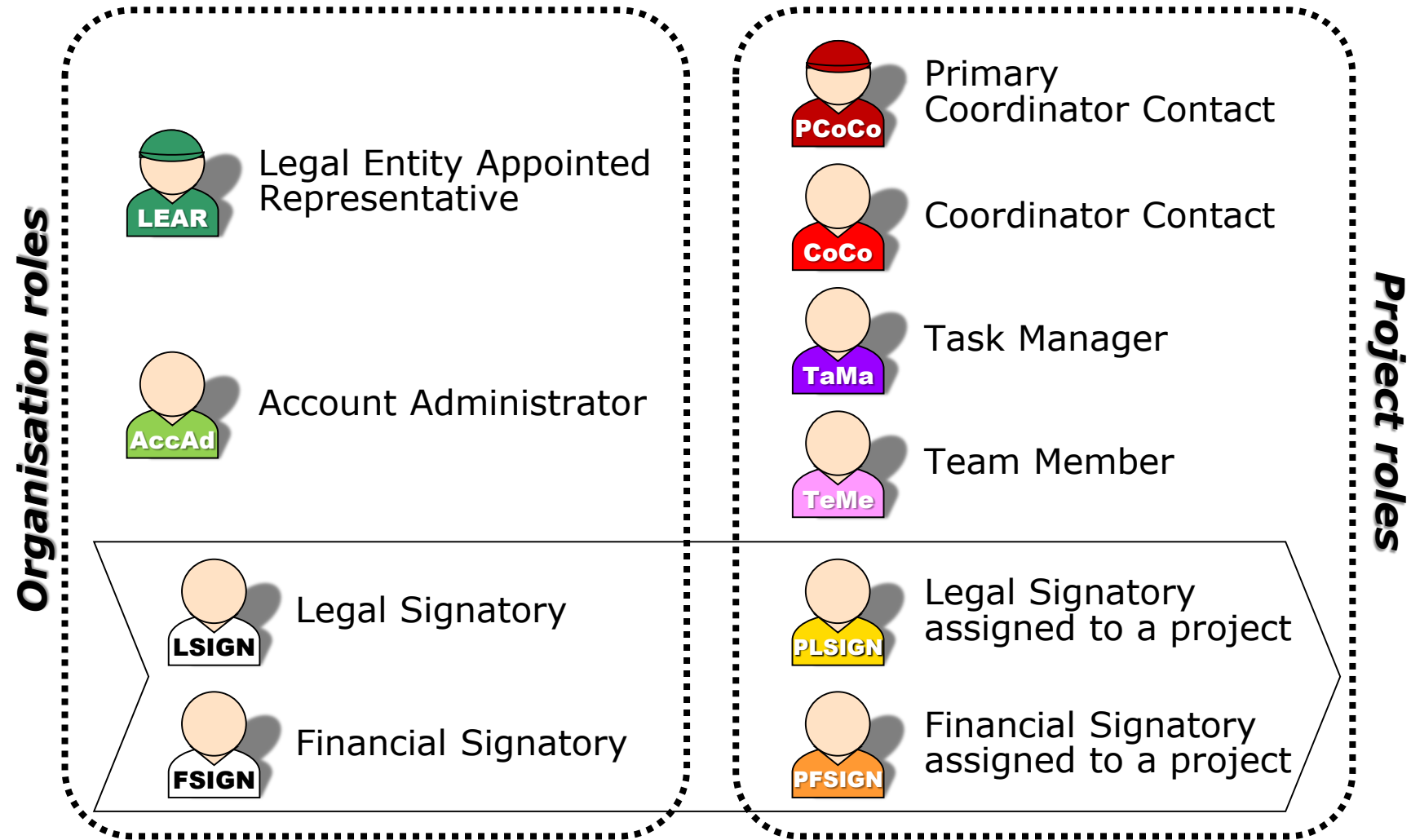

Important remarks



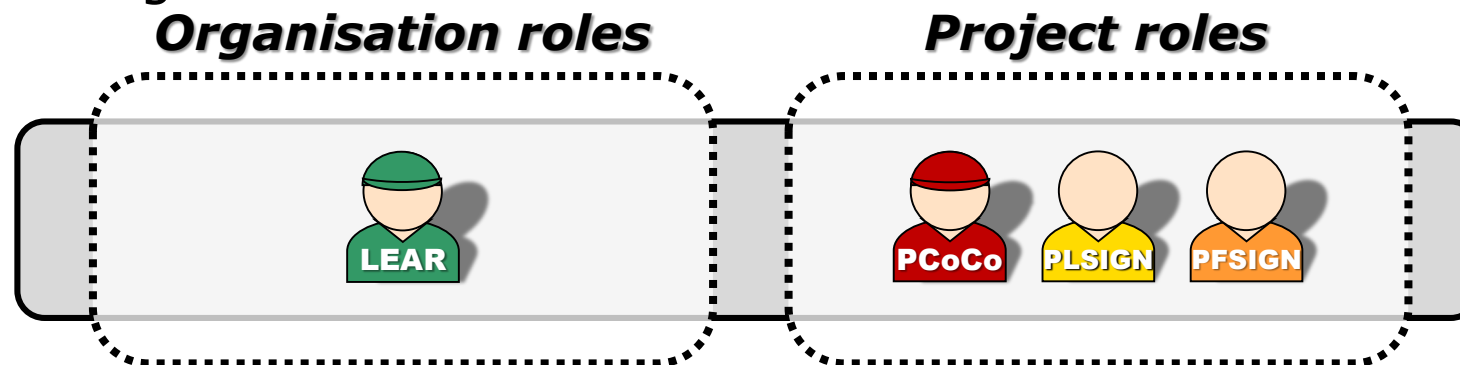
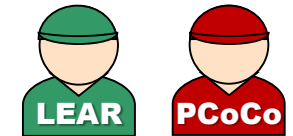

- Only the **LEAR** and **Primary Coordinator Contact** are defined/modified by the Commission.
- Only the LEAR and Primary Coordinator roles are **unique**. There is no technical limitation in the amount of other roles (you may appoint as many or as few as needed).
- One person can have **several roles at the same time**.
- Minimum configuration:







Access rights

Project roles

   Read all forms
 Write all forms
 Submit all forms





  Read forms
 Write forms
 Sign & submit financial forms

  Read forms
 Write forms
 Sign legal forms



  Read forms
 Write forms

  Read forms

Organisation roles

  View org. data
 Modify org. data
 View lists of org.'s projects, proposals and roles



  View org. data
 View lists of org.'s projects, proposals and roles





The nomination process: “Original roles”

Some roles are automatically provisioned in the early stages of the Project (“original roles”) as follows:

- The **proposal initiator in the proposal submission phase** will automatically be recognised by the Commission as the **Primary Coordinator Contact**.
- The **LEAR is validated by the Commission** during the validation process of his/her organisation.

The nomination/revocation process

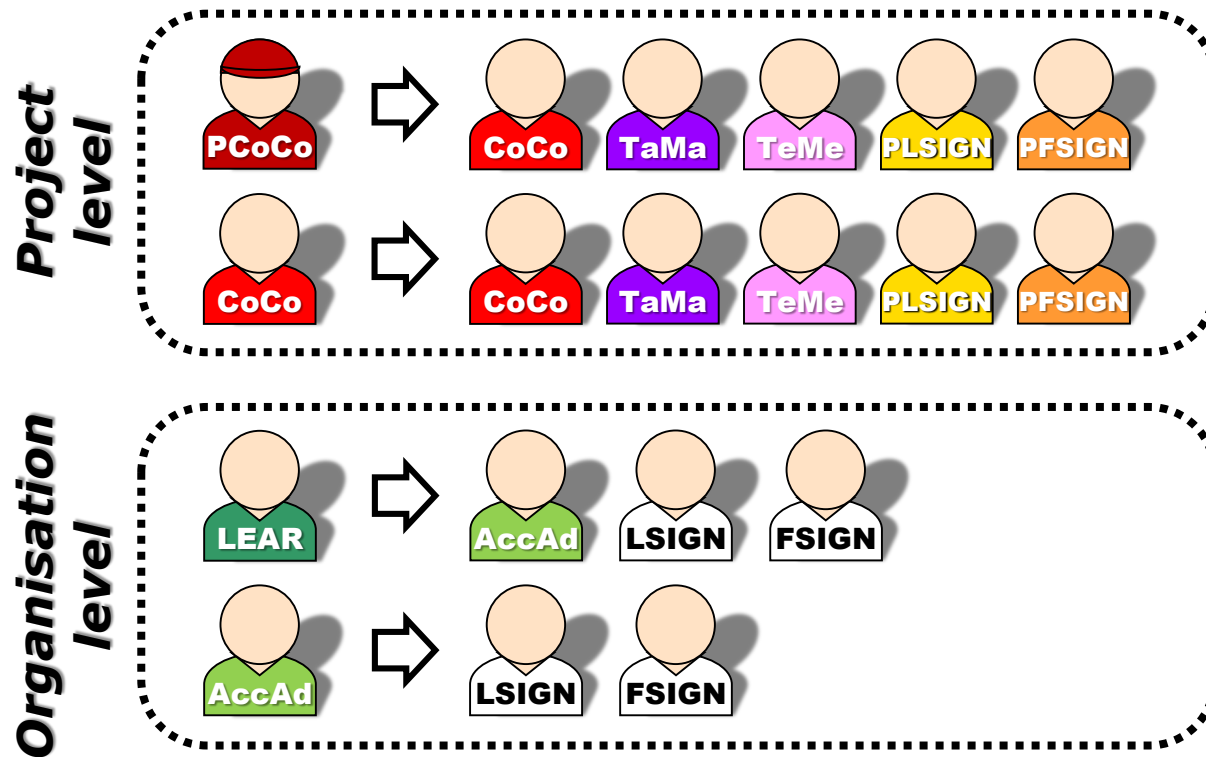



The nomination/revocation process: how to nominate/revoke someone?

To grant a role, the e-mail address of the "new user" will have to be filled in; **this e-mail address should be the same as the one used for the EU Login account** of the "new user".

If this "new user" has no EU Login account, he/she will automatically receive an invitation to create his/her EU Login account.

- Manage my area
- My Person Profile
- My Organisation(s)
- Grants
- My Proposal(s)
- My Project(s)**
- My Formal Notification(s)
- My Expert Area

SEARCH FUNDING & TENDERS | HOW TO PARTICIPATE | PROJECTS & RESULTS | WORK AS AN EXPERT | SUPPORT

My Project(s)

Results: 41

ACRONYM	CALL	PROGRAM	PROJECT	PHASE	ACTIONS
NCP-PLAYGOUND-105-UA	H2020-Adhoc-2014-20	H2020	688925		2 Actions
NCP-PLAYGROUND-01-BG		H2020	685628		Manage Consortium Manage Project View Proposal
NCP-PLAYGROUND-02-BE	H2020-Adhoc-2014-20	H2020	685555		
NCP-PLAYGROUND-03-CZ	H2020-Adhoc-2014-20	H2020	685556		Actions
NCP-PLAYGROUND-05-DE	H2020-Adhoc-2014-20	H2020	685494		Actions
NCP-PLAYGROUND-06-EE	H2020-Adhoc-2014-20	H2020	685495		Actions
NCP-PLAYGROUND-07-IE	H2020-Adhoc-2014-20	H2020	685497		Actions
NCP-PLAYGROUND-08-EL	H2020-Adhoc-2014-20	H2020	685498		Actions
NCP-PLAYGROUND-09-ES	H2020-Adhoc-2014-20	H2020	685499		Actions
NCP-PLAYGROUND-10-FR	H2020-Adhoc-2014-20	H2020	685500		Actions

"Manage Consortium"

Project roles can be granted/revoked in the "My Projects" section

- Manage my area
- My Person Profile
- My Organisation(s)
- Grants
- My Proposal(s)
- My Project(s)
- My Formal Notification(s)
- My Expert Area

SEARCH FUNDING & TENDERS | HOW TO PARTICIPATE | PROJECTS & RESULTS | WORK AS AN EXPERT | SUPPORT

My Project: Actions

NCP-PLAYGROUND-105-UA

Project ID: 688925 | Programme: H2020 | DG/Agency: RTD | Need help?

COORDINATOR	Organisation - NCP Test Company B - NCP Test Company B	EDIT ROLES
BENEFICIARY	Organisation - NCP Test University A - NCP Test University A	EDIT ROLES
BENEFICIARY	Organisation - NCP Test Company E - NCP Test Company E	EDIT ROLES





View the organisation's basic details and full list of project roles

Edit roles (only if you are Primary Coordinator Contact or Coordinator Contact)

Roles for the organisation:

NCP Test Company B
In project: **NCP-PLAYGROUND-105-UA**

Results: 6

ROLE	NAME	EMAIL	USERNAME	TEAM	ACTIONS
Coordinator Contact	Leonardo Paoli	leonardo.paoli@ec.europa....	paolile		
Coordinator Contact	Peter Haertwich	peter.haertwich@ec.europa...	hartwpe		
Coordinator Contact	Noemi Horvath	noemi.horvath@ext.ec.euro...	horvano		
Coordinator Contact	Olivier Marganne	olivier.marganne@ext.ec.e...	margaol		
Coordinator Contact	Emmanuel CROLLEN	emmanuel.crollen@ext.ec....	crollem		
Primary Coordinator Contact	Piret Noukas	piret.noukas@ec.europa.eu	noukapl		

[Go back](#)[Add roles](#)[Enable Lear Access](#)[Disable Lear Access](#)**Add new role****Revoke existing role**Organisation:
NCP Test Company B

PIC: 934525646

EE - Test City
Test Street 1

- Manage my area
- My Person Profile
- My Organisation(s)**
- Grants
- My Proposal(s)
- My Project(s)
- My Formal Notification(s)
- My Expert Area

My Organisation(s)

Results: 13

Search..

LEGAL NAME	PIC	VAT	STATUS	ACTIONS
NCP Test University A	934526519			Actions
UNIVERSITY OF LEEDS	999975426	GB613451470		Actions
THE BRUSSELS OFFICE SA	958300443	BE0476213184		Actions
NCP Test Company B	934525646			Actions
NCP Test Research Org D	934188086			Actions
NCP Test University F	934187795			Actions
DEBRECENI EGYETEM	999881239	HU17782218		Actions
NCP test SME C	934188280			Actions
CENTRE NATIONAL DE LA RECHERCHE SCIENTIFIQUE CNRS	999997930	FR40180089013		Actions
Test - Hegyvarine Nagy Agnes	954905831			Actions

"View roles"

- View Organisation
- Modify Organisation
- View Projects
- View Roles**
- View Proposals
- Edit Organisation Roles
- View Partner Search Profile

Organisation roles can be granted/revoked in the "My Organisations" section

- Manage my area
- My Person Profile
- My Organisation(s)
- Grants
- My Proposal(s)
- My Project(s)
- My Formal Notification(s)
- My Expert Area

My Organisation: NCP Test Company B

- Details
- Roles**
- Projects
- Proposals

To view users linked to the organisation, search by name, by role, or download the full list. To manage horizontal roles within the organisation (account administrators, financial and legal signatory), click on the 'Edit organisation roles'.

Search for specific roles/persons within your organisation

Show all the roles for this organisation







Edit Organisation Roles (only if you are LEAR or Account Administrator)

- Manage my area
- My Person Profile
- My Organisation(s)
- Grants
- My Proposal(s)
- My Project(s)
- My Formal Notification(s)
- My Expert Area

Roles for the organisation:

NCP Test Company B

Results: 11

ROLE	NAME	EMAIL	USERNAME	TEAM	ACTIONS
Account Administrator	Olivier Marganne	olivier.marganne@ext.ec.e...	margaol		
Account Administrator	Peter HÄRTWICH	peter.haertwich@gmx.net	nhaertpr		
Account Administrator	Peter Haertwich	peter.haertwich@ec.europa...	hartwpe		
Account Administrator	Agnes Hegyvarine nagy	agnes.nagy-hegyvarine@ec.europa.eu	nagyhag		
Account Administrator	Jorge CAMPOS VALLEJO	jorge.campos-vallejo@ec.europa.eu	campoje		
Account Administrator	Emmanuel CROLLEN	emmanuel.crollen@ext.ec...	crollem		
Financial Signatory	Agnes Hegyvarine nagy	agnes.nagy-hegyvarine@ec.europa.eu	nagyhag		 
LEAR	Peter Haertwich	postph@posteo.de	nhaertpt		
Legal Signatory	Gluseppina LAURITANO	gluseppina.lauritano@ec.e...	lauriga		 
Legal Signatory	Olivier Marganne	olivier.marganne@ext.ec.e...	margaol		 

Organisation:
NCP Test Company B

PIC: 934525646

EE - Test City
Test Street 1

[Go back](#) [Add roles](#)

Edit/Revoke existing role

Add new role

My Organisation(s)

Results: 13

Search..

LEGAL NAME	PIC	VAT	STATUS	ACTIONS
NCP Test University A	934526519			Actions
UNIVERSITY OF LEEDS	999975426	GB613451470		Actions
THE BRUSSELS OFFICE SA	958300443	BE0476213184		Actions
NCP Test Company B	934525646			Actions
NCP Test Research Org D	934188086			Actions
NCP Test University F				Actions
DEBRECENI EGYETEM	999881239	HU17782218		Actions
NCP test SME C	934188280			Actions
CENTRE NATIONAL DE LA RECHERCHE SCIENTIFIQUE CNRS	999997930	FR40180089013		Actions
Test - Hegyvarine Nagy Agnes	954905831			Actions

"Modify Organisation"

- View Organisation
- Modify Organisation
- View Projects
- View Roles
- View Proposals
- Edit Organisation Roles
- View Partner Search Profile

**LEAR role can be determined
in the "My Organisations" section**



Research & innovation

Funding & Tenders Portal - Participant registration

European Commission > Research & Innovation > Funding & Tenders Portal > Participant Register

Welcome **Olivier MARGANNE**. You can edit the data of organisation **NCP Test Company B**

PIC: 934525646

Activity log

Organisation

LEAR

Bank Accounts

Programme specific
information

SME

Financial capacity

Messages 3

Documents

Submit changes

Activity log

HOW TO

New messages You have 3 unread messages. [View](#)

Organisation

ORGANISATION DATA

Legal name *		<input type="text" value="NCP Test Company B"/>	
Business name		<input type="text" value="NCP Test Company B"/>	
<i>Please select here below the appropriate option to describe the beneficiary</i>			
Legal status		<input type="radio"/> a natural person <input checked="" type="radio"/> a legal person	
		<input checked="" type="radio"/> private entity <input type="radio"/> public body	
		<input type="radio"/> non-profit <input checked="" type="radio"/> for profit	
Official Language *		<input type="text" value="Estonian (et)"/>	
Country *		<input type="text" value="Estonia (EE)"/>	
LegalForm *		<input type="text" value="AKTSIASELTS"/>	
VAT *		<input type="text" value="VAT number"/>	
		<input checked="" type="checkbox"/> VAT number not applicable	
Registration Number		<input type="text" value="not applicable"/>	
Registration Date		<input type="text" value="01-01-1900"/>	
Registration Authority		<input type="text" value="not applicable"/>	

Legal Address

Beneficiary's legal address

The nomination process: LSIGN/FSIGN

1. **Organisation level** *Project level*

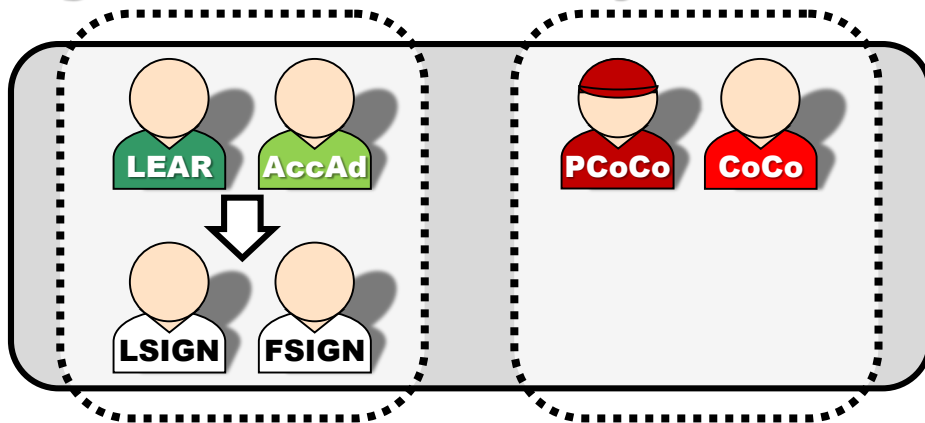

The **LEAR (or Account Administrators)** nominate as many LSIGNs / FSIGNs as they want.

At this stage, the FSIGN cannot do anything, while the LSIGN has read-only access to the organisation's data and lists of projects, proposals & roles.

2. **Organisation level** *Project level*

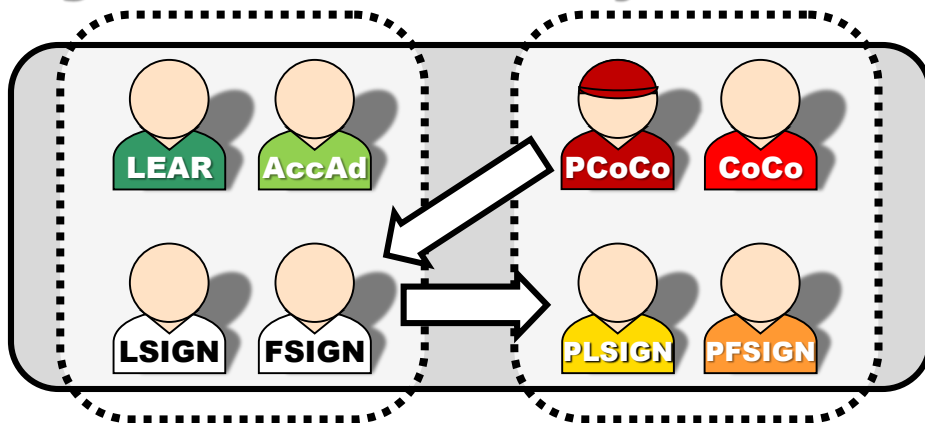

The **(Primary) Coordinator Contacts / Participant Contacts** need to assign to their project as many LSIGNs / FSIGNs for their own organisation as needed.

The PLSIGN and PFSIGN now have access to the tools.



Organisation roles: what can I do?

- 1. Manage the registration of the organisation**
- 2. Update the organisation's data in the Participant Register**
- 3. Read-only access to the organisation's list of all roles, proposals and projects**
- 4. Nominate/revoke organisation roles**
- 5. Manage public organisation profile and "partner search" requests**

Search by Involvement in EU funded programmes

Keyword
Type your Keywords

Topic
Type a topic ...

Call
Select a call ...

Programme
Select a Programme...

Search by Organisation details

Organisation name
fraunhofer

Organisation type
-

Country
-

City
-

Partner Search

Need help?

Any use of the Funding and Tenders Portal for a commercial purpose is forbidden. Any misuse of it will lead to the refusal of access to the Funding and Tenders Portal.

Find partners for your project ideas among the participants in past EU projects.

- Enter a keyword or a topic of a past call for proposals for finding related organisations.
- Search by geographical criteria or by types of organisation.
- For more specialised partner search service see Online Manual.

Results: **12**

ORGANISATION NAME	ORGANISATION TYPE	ORGANISATION STATUS	COUNTRY	CITY	#PROJECTS
FRAUNHOFER GESELLSCHAFT ZUR FOERDERUNG DER ANGEWANDTEN FORSCHUNG E.V.	Non-governmental organization	VALIDATED	Germany	MUNCHEN	2285
Fraunhofer Austria Research GmbH	Research Organisation	VALIDATED	Austria	Vienna	5
STIFTELSEN FRAUNHOFER-CHALMERS CENTRUM FOR INDUSTRIEMATEMATIK	Small or medium-size enterprise	VALIDATED	Sweden	GOETEBORG	5
ASSOCIACAO FRAUNHOFER PORTUGAL RESEARCH	Research Organisation	VALIDATED	Portugal	PORTO	4
FRAUNHOFER UK RESEARCH LIMITED	Research Organisation	VALIDATED	United Kingdom	GLASGOW	4
FRAUNHOFER ITALIA RESEARCH SCARL	Research Organisation	VALIDATED	Italy	BOLZANO	3
FUNDACION FRAUNHOFER CHILE					

Public organisation profile

Partner search:
FRAUNHOFER GESELLSCHAFT ZUR FOERDERUNG DER ANGEWANDTEN FORSCHUNG E.V.

PIC: 999984059

Germany - MUNCHEN Non-governmental organization 2285 projects funded

Contact organisation

Description

The Fraunhofer-Gesellschaft is the leading organization for applied research in Europe. Its research activities are conducted by 69 institutes and research units at locations throughout Germany. The Fraunhofer-Gesellschaft employs a staff of 24,500, who work with an annual research budget totaling 2.1 billion euros. Of this sum, 1.9 billion euros is generated through contract research. More than 70 percent of the Fraunhofer-Gesellschaft's contract research revenue is derived from contracts with industry and from publicly financed research projects. International collaborations with excellent research partners and innovative companies around the world ensure direct access to regions of the greatest importance to present and future scientific progress and economic development.

Tags/Keywords

- Electrical and electronic engineering: semiconductors, components, systems
- Materials engineering
- big data
- innovation
- Interoperability
- Renewable electricity
- Materials engineering (biomaterials, metals, ceramics, polymers, composites, etc.)
- machine learning
- modelling
- energy efficiency
- simulation
- Cyber-physical systems
- Nanotechnology, nano-materials, nano engineering
- Artificial intelligence, intelligent systems, multi agent systems
- recycling

General description and keywords* (editable by LEAR/Account Administrators)

*Default keywords list comes from the funded projects

- Charts pie
- Main collaboration partners
- Projects list
- Published partner searches

Programmes

RFCS(3) CREA(1) ISFP(2) H2020(1048) CIP(23) FP7(1207) EPLUS(1)



Roles

BENEFICIARY(1880) THIRD PARTY(12) COORDINATOR(393)



- Manage my area
- My Person Profile
- My Organisation(s)
- Grants
- My Proposal(s)
- My Project(s)
- My Formal Notification(s)
- My Expert Area

Partner search: **FRAUNHOFER ANGEWANDTE**

Germany - MUNCHEN

PIC: 999984059

Contact organisation

Contact the Participant Contacts of the organisation

Dear Participant Contact (*) of FRAUNHOFER GESELLSCHAFT ZUR FOERDERUNG DER ANGEWANDTEN FORSCHUNG E.V. in the project TIMON,

I am contacting you for the following reason:

My Name: Olivier MARGANNE

My Email: Olivier.MARGANNE@ext.ec.europa.eu

I agree to use this Contact Request Form in accordance with the [Terms and Conditions](#) of the Funding & Tenders Portal electronic exchange system. I acknowledge, in particular, that the use of the Contact Form for any commercial purpose is forbidden.

(*) Your email will be sent to all the individuals who have the Participant Contact role (or Coordinator Contact role if the above organisation is the coordinating organisation) in the above project. [More information on roles management](#)

No personal information is disclosed through this form!

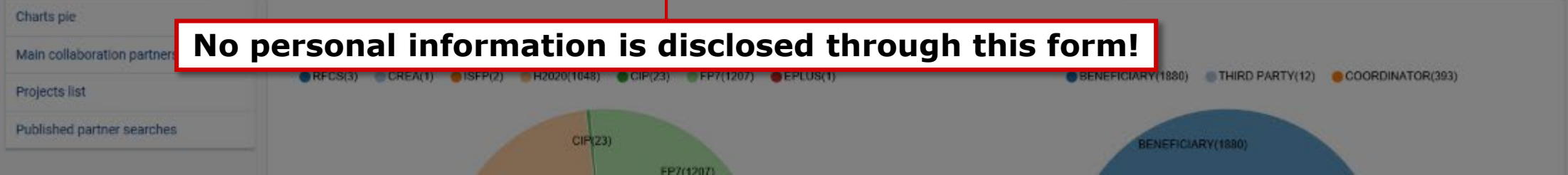



What to do in case of spam and phishing related to the Funding & Tenders Portal?

From time to time spam and phishing occur. Several types of spam and phishing can be distinguished:

1. phishing attempts pretending to come from the Funding & Tenders Portal, asking for vital personal and financial data such as ID or bank account details. Such e-mails may also ask you to click on a link or download an attachment to update your pertinent information there;
2. spam looking identical to Funding & Tenders Portal notifications but not actually stemming from the Funding & Tenders Portal;
3. inappropriate use of the Funding & Tenders Portal contact function to send unsolicited messages regarding commercial services.

Your first action against spam and phishing is to be vigilant. Protect yourself by keeping the following in mind:

1. The Funding & Tenders Portal will never ask you to send important personal and financial information via email. When logging on to the Funding & Tenders Portal, check that you use the default URL address <https://ec.europa.eu/info/funding-tenders/opportunities/portal/> as the starting point and the page links where you introduce the personal and financial data start with <https://ec.europa.eu/research/>
2. Ignore phishing messages. Do not be coerced into following their instructions simply because they have threatened you that something will happen to your account or to your application for EU funding if you do not respond.
3. Exercise caution when opening attachments or downloading files. These may contain viruses or software that may pose security threats to your computer.
4. Update your user password regularly. Do not use passwords that can be easily attributed to you such as your name or birthday.

Report any suspicion of a phishing incident to us via our [IT Service Desk](#).

<https://ec.europa.eu/info/funding-tenders/opportunities/portal/screen/support/faq/7942>



More functionalities



Funding & Tenders Portal services: after login

My Project(s)

- 1. Access to the list of projects the user is involved in**
- 2. Access to the project-related services:**
 - Grant preparation / Grant signature**
 - Amendments**
 - Reporting tools**
- 3. View of the consortium's roles for a given project**
- 4. Grant/revoke roles for a given project**
(provided the user has the authorisation to do so)



Paperless submission

- LEAR nominates a list of persons authorised to sign legal & financial statements
- Only these persons get access to the "**Sign and submit**" function in the tool
- "Sign and submit" triggers the creation of an **eReceipt** that is stored in the electronic project archive
- All persons needing to know (including the LEAR) are **notified** on the transaction and have access to the eReceipt



Value of the eReceipt

- Electronic receipt = **digitally signed PDF version of the submitted document.**
- Both the content of the document and a set of metadata (time stamp, EU Login credentials of submitter) are digitally sealed.
- The digital signature mechanism, using a public-private key pair mechanism, uniquely binds the eReceipt to the transaction and **ensures its full integrity.** Therefore a **complete digitally-signed trail of the transaction is available** both for the beneficiaries and the Commission.
- **Any attempt to modify the content will lead to a break of the integrity of the electronic signature,** which can be verified at any time by clicking on the signature in the PDF document.
- The eReceipt is stored in the project archive where it **can be downloaded at any time by any actor in the project** and stored on other electronic media.



Funding & Tenders Portal services: after login

My Notification(s)

1. View all personal notifications for the services of the Funding & Tenders Portal

- Examples: change of roles, forms ready to be signed, availability of e-receipts, etc.

- Manage my area
- My Person Profile
- My Organisation(s)
- Grants
- My Proposal(s)
- My Project(s)
- My Formal Notification(s)
- My Expert Area

SEARCH FUNDING & TENDERS | HOW TO PARTICIPATE | PROJECTS & RESULTS | WORK AS AN EXPERT | SUPPORT

Find calls for proposals and tenders

EU Programmes

Programming period 2014-2020

European Maritime and Fisheries Fund (EMFF)	European Statistics (ESTAT)	Innovation Fund (INNOVFUND)	EU External Action (RELEX)	Hercule III (HERC)
Horizon 2020 Framework Programme (H2020)	Support for information measures relating to the common agricultural policy (IMCAP)	Internal Security Fund Borders and Visa (ISFB)	Internal Security Fund Police (ISFP)	Justice Programme (JUST)

[Show all \(30\)](#)

View your notifications

[ERA corona platform](#) [Brexit info](#) [Report fraud](#)

News

29 Dec, 2020
Finding Calls for Tenders on the Funding and Tenders Portal

18 Dec, 2020
DIGIT Support for eGrants and eProcurement external users are moving together

18 Dec, 2020
Attention: Phishing attempts through the contact functionality of the F&T Portal

[All news >](#)

How to participate in 5 steps

- 1 Find an opportunity
- 2 Find partner(s)
- 3 Create an account
- 4 Register your organisation
- 5 Submit your proposal or offer

Learn how to find and apply for suitable EU funding and tender opportunities.

[Learn more](#)

- ### Useful links
- [Calls for tenders on Ted](#)
 - [Overview of all EU funding opportunities](#)
 - [Access to publications and data on OpenAire](#)
 - [Apply for EU loans & venture capital](#)

- Manage my area
- My Person Profile
- My Organisation(s)
- Grants
- My Proposal(s)
- My Project(s)
- My Formal Notification(s)
- My Expert Area

SEARCH FUNDING & TENDERS | HOW TO PARTICIPATE | PROJECTS & RESULTS | WORK AS AN EXPERT | SUPPORT

Find calls for proposals and tenders

EU Programmes

Programming period 2014-2020

European Maritime and Fisheries Fund (EMFF)	European Statistics (ESTAT)	Innovation Fund (INNOVFUND)	EU External Action (RELEX)	Hercule III (HERC)
Horizon 2020 Framework Programme (H2020)	Support for information measures relating to the common agricultural policy (IMCAP)	Internal Security Fund Borders and Visa (ISFB)	Internal Security Fund Police (ISFP)	Justice Programme (JUST)

[Show all \(30\)](#)

How to participate in 5 steps

- 1 Find an opportunity
- 2 Find partner(s)
- 3 Create an account
- 4 Register your organisation
- 5 Submit your proposal or offer

Learn how to find and apply for suitable EU funding and tender opportunities.

[Learn more](#)

My notifications

- 05/01/2021 20 days ago **Funding & Tenders Portal** Request to get in contact with the Self Registrant of 915907369 - TEST TEST TEST TEST
- 18/12/2020 39 days ago **Funding & Tenders Portal** Request to get in contact with the Self Registrant of 915907369 - TEST TEST TEST TEST
- 09/11/2020 77 days ago **Funding & Tenders Portal** INFO: Role of Financial Signatory revoked for your organisation <934187795 - NCP Test University F>
- 09/11/2020 77 days ago **Funding & Tenders Portal** INFO: Allocation of role of Financial Signatory for organisation <934187795 - NCP Test University F>
- 09/11/2020 78 days ago **Submission and evaluation system** A proposal where the Participant Identification Code (PIC) of your organisation was inserted as partner has been withdrawn.
- 09/11/2020 78 days ago **Submission and evaluation system** The Participant Identification Code (PIC) of your organisation was inserted as partner in a proposal.
- 20/10/2020 98 days ago **Submission and evaluation system** A proposal where the Participant Identification Code (PIC) of your organisation was inserted as partner has been withdrawn.
- 19/10/2020 99 days ago **PPGMS** Your EU project 688926 - NCP-PLAYGROUND-COMST - GAP-688926; new message from Project Officer
- 02/10/2020 116 days ago **Funding & Tenders Portal** Request to get in contact with the Self Registrant of 915907369 - TEST TEST TEST TEST
- 21/09/2020 127 days ago **Funding & Tenders Portal** Request to get in contact with the Self Registrant of 915907369 - TEST TEST TEST TEST
- 12/09/2020 136 days ago **Submission and evaluation system** The Participant Identification Code (PIC) of your organisation was inserted as partner in a proposal.









[Manage all notifications](#)

News

- 29 Dec, 2020 **Finding Ca**
- The EuropeAl Calls for Prop ...
- 18 Dec, 2020 **DIGIT Supp moving tog**
- Within the cor teams for ePr un...
- 18 Dec, 2020 **Attention: I of the F&T**
- Several Fundi emails throu Pro...

Useful link

-
-
-
-

-  [Manage my area](#)
-  [SEARCH FUNDING & TENDERS](#) ▾
- [HOW TO PARTICIPATE](#) ▾
- [PROJECTS & RESULTS](#)
- [WORK AS AN EXPERT](#)
- [SUPPORT](#) ▾
-  [My Person Profile](#)
-  [My Organisation\(s\)](#)
-  [Grants](#) ▾
-  [My Proposal\(s\)](#)
-  [My Project\(s\)](#)
-  [My Formal Notification\(s\)](#)
-  [My Expert Area](#)

My Notification(s)

Inbox

Preferences

Results: **187**

<input type="checkbox"/>	DATE ▾	SOURCE ↕	SUBJECT ↕	PRIORITY ↕
<input type="checkbox"/>	05-01-2021 17:47:33	Funding & Tenders Portal	Request to get in contact with the Self Registrant of 915907369 - TEST TEST TEST TEST	HIGH
<input type="checkbox"/>	18-12-2020 12:15:06	Funding & Tenders Portal	Request to get in contact with the Self Registrant of 915907369 - TEST TEST TEST TEST	HIGH
<input type="checkbox"/>	09-11-2020 17:52:40	Funding & Tenders Portal	INFO: Role of Financial Signatory revoked for your organisation <934187795 - NCP Test University F>	HIGH
<input type="checkbox"/>	09-11-2020 17:40:33	Funding & Tenders Portal	INFO: Allocation of role of Financial Signatory for organisation <934187795 - NCP Test University F>	HIGH
<input type="checkbox"/>	09-11-2020 10:00:00	Submission and evaluation system	A proposal where the Participant Identification Code (PIC) of your organisation was inserted as partner has been withdrawn.	NORMAL
<input type="checkbox"/>	09-11-2020 09:45:55	Submission and evaluation system	The Participant Identification Code (PIC) of your organisation was inserted as partner in a proposal.	NORMAL
<input type="checkbox"/>	20-10-2020 09:36:40	Submission and evaluation system	A proposal where the Participant Identification Code (PIC) of your organisation was inserted as partner has been withdrawn.	NORMAL
<input type="checkbox"/>	19-10-2020 09:00:01	PPGMS	Your EU project 688926 - NCP-PLAYGROUND-COMST - GAP-688926; new message from Project Officer	HIGH
<input type="checkbox"/>	02-10-2020 11:07:46	Funding & Tenders Portal	Request to get in contact with the Self Registrant of 915907369 - TEST TEST TEST TEST	HIGH
<input type="checkbox"/>	21-09-2020 09:20:20	Funding & Tenders Portal	Request to get in contact with the Self Registrant of 915907369 - TEST TEST TEST TEST	HIGH

⏪ ⏩ 1 2 3 ▶ ⏪ 10 ▾

Delete Selected

Mark Selected Read

Mark All Read

Mark Selected Unread



Funding & Tenders Portal services: **after login**

My Formal Notification(s)

1. View all formal notifications for the services of the Funding & Tenders Portal

- **Can be used ONLY for correspondence requiring acknowledgement of receipt**

Examples: termination of a grant, etc.



Funding & Tenders Portal services: **after login**

My Account

- 1. My roles:** list of all the roles linked to the EU Login account
- 2. Security Settings:** you can activate the 2-step verification by registering your mobile device
- 3. IT Helpdesk**
- 4. My Account:** information about your EU Login account
- 5. Logout**

- Manage my area
- My Organisation(s)
- My Formal Notification(s)
- My Expert Area

- SEARCH FUNDING & TENDERS
- HOW TO PARTICIPATE
- PROJECTS & RESULTS
- WORK AS AN EXPERT
- SUPPORT

Find calls for proposals and tenders

EU Programmes

Programming period 2014-2020

Horizon 2020 Framework Programme (H2020)	Support for information measures relating to the common agricultural policy (IMCAP)	Internal Security Fund Borders and Visa (ISFB)	Internal Security Fund Police (ISFP)	Justice Programme (JUST)
Pilot Projects and Preparatory Actions (PPPA)	Programme for the Competitiveness of Enterprises and small and medium-sized enterprises (COSME)	Programme for the Environment and Climate Action (LIFE)	Promotion of Agricultural Products (AGRIP)	Research Fund for Coal & Steel (RFCS)

[Show all \(30\)](#)

How to participate in 5 steps

- 1 Find an opportunity
- 2 Find partner(s)
- 3 Create an account
- 4 Register your organisation
- 5 Submit your proposal or offer

Learn how to find and apply for suitable EU funding and tender opportunities.





ERA corona





News

29 Dec, 2020
Finding Calls for Tenders or
The EuropeAid website has been ph...
Calls for Proposals. External partne...
...

18 Dec, 2020
DIGIT Support for eGrants and eProcurement external users are moving together
Within the context of the Synergies and Efficiencies Initiative, the DIGIT Support teams for eProcurement and for eGrants (GMSS) are now joining their forces un...

18 Dec, 2020
Attention: Phishing attempts through the contact functionality of the F&T Portal
Several Funding & Tenders Portal users reported to us that they received emails through the contact form of the F&T Portal ("Contact LEAR", "Contact Pro...
[All news >](#)

- ### Useful links
-  [Calls for tenders on Ted](#)
 -  [Overview of all EU funding opportunities](#)
 -  [Access to publications and data on OpenAire](#)
 -  [Apply for EU loans & venture capital](#)

-  My roles
-  Security Settings
-  IT Helpdesk
-  My Account
-  Logout

- Manage my area
- My Person Profile
- My Organisation(s)
- Grants
- My Proposal(s)
- My Project(s)
- My Formal Notification(s)
- My Expert Area

My Roles

My roles

Need help?

Organisation Roles List

Results: 7

Search..

PIC	ORGANISATION NAME	ROLE
915907369	TEST TEST TEST TEST	Self Registrant
934187795	NCP Test University F	Account Administrator
934187892	NCP Test Company E	Account Administrator
934188086	NCP Test Research Org D	Account Administrator
934188280	NCP test SME C	Account Administrator
934525646	NCP Test Company B	Account Administrator, Legal Signatory
934526519	NCP Test University A	Account Administrator

10

Project Roles List

Results: 41

Search..

ACRONYM	PROJECT ID	PROGRAM	ROLE	PIC
NCP-PLAYGROUND-105-UA	688925	H2020	Coordinator Contact	934525646



My Account



My account details



Modify my personal data



Delete my account



Manage my mobile devices



Manage my Security Keys and Trusted Platforms



Manage my mobile phone numbers



Link my eID

You can link your eID to your EU Login account.



Display my sessions

You can view the sessions opened for visited applications.

Click on the gear icon if you want to change your EU Login password



Need help?





Need help?

Support

1. Guidance & Manuals

- Access the [Online Manual](#) (guide for **business processes**)
- Access the [IT How To](#) wiki (guide for **IT processes**)

2. FAQ

3. Helpdesks

The support section is also **Programme-based**; some specific helpdesks & guidance documents will only be available for a dedicated Programme.

Find guidance, process by process (drill-down approach)

- Online Manual
- > My Area — User account and roles
- > Participant Register — Register your
- > Grants
- Procurement
- Prizes
- Financial instruments
- > Working as an expert
- Help

Online Manual

My Area — User account and roles

Grants

Applying for funding

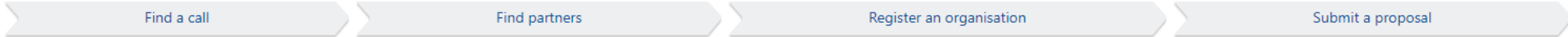

Evaluation & Grant signature

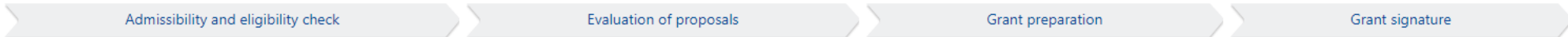

Grant management



Working as an expert

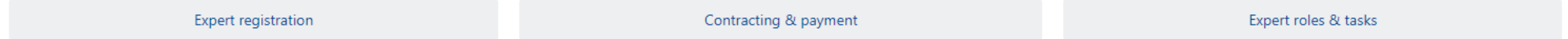

- Prizes
- Financial instruments
- Procurement

Pages

IT How To

IT How To

On this site you will find all the information on HOW TO USE the services available in the [Funding & Tenders Portal](#).

This portal is used for funding programmes and tenders managed by the European Commission, Executive Agencies and other EU bodies, as well as some actions for Education, Audio-visual Culture, Citizenship and Volunteering projects managed by National Agencies under the programmes Creative Europe / Erasmus+ / Europe for Citizens / EU Aid Volunteers.

See an introduction to your personalised area within the Portal in [Manage my area](#).

Click an icon below to access the information about specific business processes / sections in It How To.

See [IT Support](#) if you need support using the Portal.



Participants



Experts



Proposals



Grants



Audits



Roles & access rights



Procurement



What's new

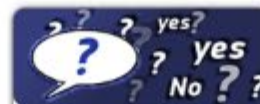

FAQ

Detailed guidance of all IT tools

Type your Keywords or question... 

GRANTS TENDERS

Filter by CATEGORY

- Roles and access rights
- Participant registration and validation...
- Funding opportunities, calls
- Proposals submission and evaluation
- Ethics and research integrity
- Grant preparation and signature, reporting...
- Audits and certificates
- Experts evaluators, reviewers, monitors
- European research policy

Programming period

Select a Programme Period... 

Filter by PROGRAMME

Select a Programme... 

[Clear filters](#)

Search the FAQ database

Frequently Asked Questions (FAQ)





These pages are updated with the answers to the most frequent questions that have been submitted to the Research Enquiry Service and Participant Validation, IT Helpdesk, eProcurement Helpdesk, Call Coordinators and H2020 NCP correspondents.

In case of questions related to a call for tenders, there is always a specific timeslot to ask questions and requesting information, clarification must be done exclusively within the call for tenders on eTendering.

[Read about calls for tenders](#)

Active(2353) | Archived(1054) 

Filter the search results by category and/or by programme

-  **Under the European Green Deal call H2020-LC-GD-2020, topic LC-GD-2-2-2020, is hydrogen produced from nuclear electricity considered clean hydrogen, and thus eligible?**
No. The call text states: "To help achieve the climate neutrality objective, hydrogen needs to be produced at large scale, mainly through electrolysis powered by renewable electricit...read more ..."
-  **Under the European Green Deal call H2020-LC-**
"Less represented areas" refers to regions and/or economic sectors for which specific and tailored climate services or solutions for mitigating or adapting to climate change are curr...read more ..."
-  **Under AMIF-2020-AG-CALL, what is the assumed target group of final beneficiaries?**
In general, the main target group for the AMIF-2020 Call are regular migrant TCNs. Irregular migrant TCNs are not excluded, but this group does not constitute the main target group. ...read more ..."
-  **Under AMIF-2020-AG-CALL, Topic AMIF-2020-AG-CALL-05, can some expenses, whenever relevant, be foreseen for activities to be carried out directly in countries of origin?**
Proposals may envisage to incur costs related to activities to be carried out directly in the countries of origin. Applicants should prepare their proposal, i.e. description of the a...read more ..."



Thank you!

Any questions?

Olivier MARGANNE

olivier.marganne@ext.ec.europa.eu

Common Implementation Centre – Business Processes – RTD H3